

2/2-Way; G 3/8"-G 1"; 1-10 bar



Advantages/Benefits

- ▶ High lifetime also under pulsed conditions
- ▶ Solutions for rough air applications
- ▶ High reliability
- ▶ Compact design with high flow rates
- ▶ Modular solenoid coil system different sizes and power ratings
- ▶ Low noise
- ▶ Easy coil change
- ▶ Coil can be locked in 4x 90° positions, or move freely between, as required
- ▶ Wide range of cable plug options Type 2508

Design/Function

The valves are based on a modular concept comprising three basic elements: Valve assembly, push-over coil and standard cable plug.

This valve is specifically designed for general purpose applications with air. The design principle of this valve allows high pulsed operations in air pipe runs, where other general purpose valves cannot be used, as they start to vibrate quickly. So life-time of this valve could be substantially increased, compared to other solutions.

A minimal pressure differential of 1bar is required for complete opening.

To simplify ordering, a wide selection of standard combinations of valve body, push-over coil and standard cable plug can be ordered with one order number.

Cable plug options of Type 2508 are available to suit special electrical application requirements.

- The modular concept provides flexibility to meet application requirements.

Applications

Fluids

- Compressed air also with higher pulse rates

Applications

- Pneumatic systems
- Compressed air circuits

burkert
Easy Fluid Control Systems

Technical Data

Circuit function

A 2/2-way, normally closed (N.C.),
servo-piston valve,
2-way pilot controlled

Symbol

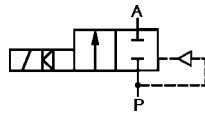

Operating Data (Valve)

Pressure range	1-10 bar
Port connection	G 3/8" - G 1"
Fluid	Seal material NBR: Compressed air pulsed air,
Medium temperature	-10 ... +90 °C
Max. ambient temperature	+55 °C
Response times	opening: 80-100 ms ¹⁾ closing: 200-300 ms ¹⁾ ¹⁾ Depend on orifice and fluid pressure
Installation	as required, but preferably with solenoid system upright

Operating Data (Actuator)

Operating voltages AC: 24, 110, 230, V/50 Hz
DC: 24 V/=

Voltages tolerance ±10 %

Power consumption

Operating status	DN (mm)		
	10	13	20
AC: inrush	34 VA	36 VA	38 VA
AC: hold	14 VA/ 8 W	14 VA/ 8 W	14 VA/ 8 W
DC: inrush and hold	10 W	10 W	10 W

Duty cycle 100% continuously rated

Cycling rate up to 20 c.p.m.

Protection class with
cable plug IP 65

Electr. connection Delivery standard:
Cable plug DIN 43 650 A,
0-250 V (Other versions
see accessories).

Materials

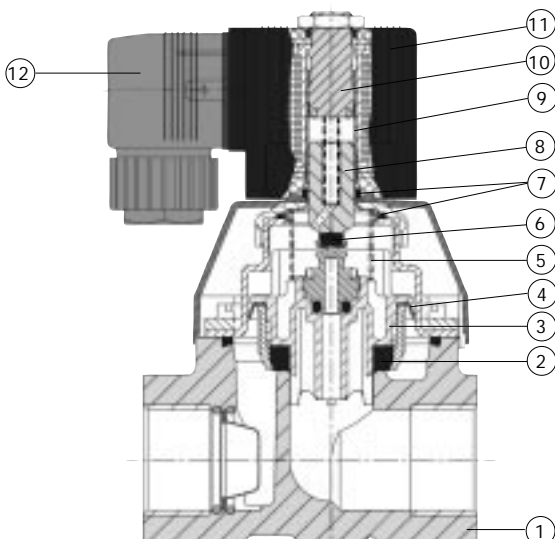

1	Valve body:	Brass
2	Seat-seal:	NBR
3	Piston:	PPS
4	Gasket:	PTFE
5	Spring:	1.4310
6	Plunger-seal:	NBR
7	O-rings:	NBR
8	Plunger:	1.4105
9	Armature guide tube:	1.4301
10	Stopper:	1.4105
11	Coil	Polyamide
12	Cable plug:	Polyamide

Specifications - Ordering Chart (Other Versions on Request)

Brass valve body; seal material NBR

(with standard-cable plug, 0-250 V AC/DC)

Port connection [Inch]	Orifice [mm]	Q _{Nn} -value (air) [l/min]	Pressure Range [bar]	Seal material	Weight [kg]	ORDER - NO.			
						Voltage / Frequency [V/Hz]			
						24/=	24/50	110/50	230/50
G 3/8	10.0	1300	1-10	NBR	0.40	134 293 N	134 294 P	134 295 Q	134 296 R
G 1/2	13.0	3200	1-10	NBR	0.60	134 297 J	134 298 T	134 299 U	134 300 U
G 3/4	20.0	8700	1-10	NBR	1.00	134 301 W	134 302 X	134 303 Y	134 304 Z
G 1	20.0	8700	1-10	NBR	1.00	135 155 L	135 156 M	135 157 N	135 158 X

Dimensions (in mm)

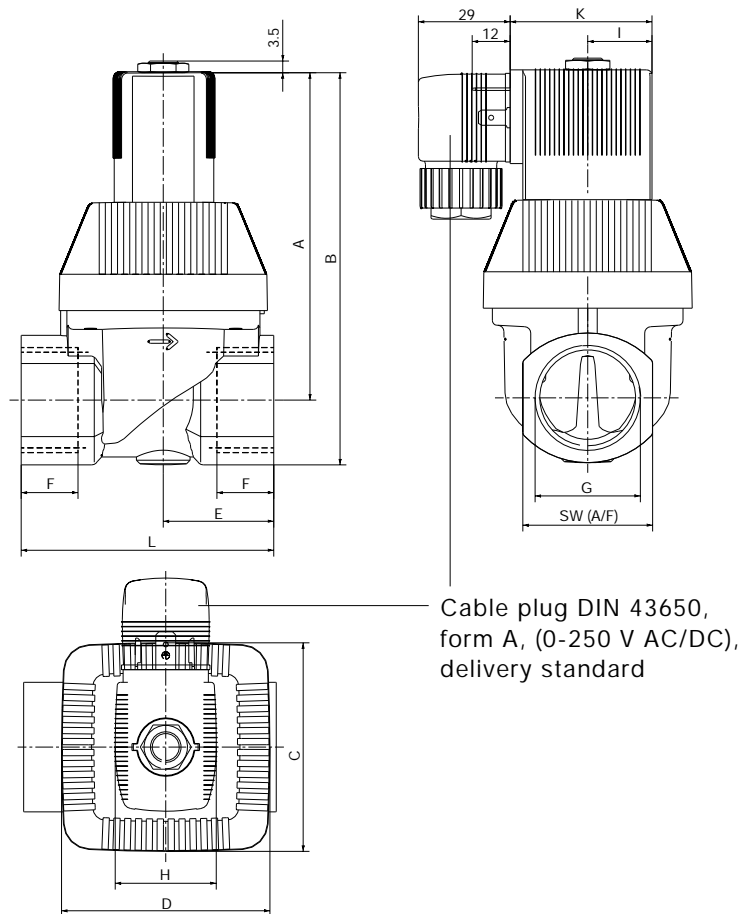

Variable dimensions [mm]

Threaded port [inch]	Orifice [mm]								AC-Coil					DC-Coil				
		C	D	E	F	L	SW	A	B	H	I	K	A	B	H	I	K	
G 3/8	10	37,5	38.0	20	12.0	50	27	72.0	86.0	32	20.5	45	68.5	82.5	40	23,5	51	
G 1/2	13	45.0	50.5	24	14.0	58	32	90,5	106.5	32	20.5	45	80.0	96.0	40	23,5	51	
G 3/4	20	66.0	66.0	35	16.0	80	41	104.5	125.0	32	20.5	45	95.5	116.0	40	23,5	51	
G 1	20	66.0	66.0	35	18.0	80	41	104.5	125.0	32	20.5	45	95.5	116.0	40	23,5	51	

Solenoid Valve for high pulsed and compressed air

General Purpose

Type 6221

Dimensions Accessories (in mm)

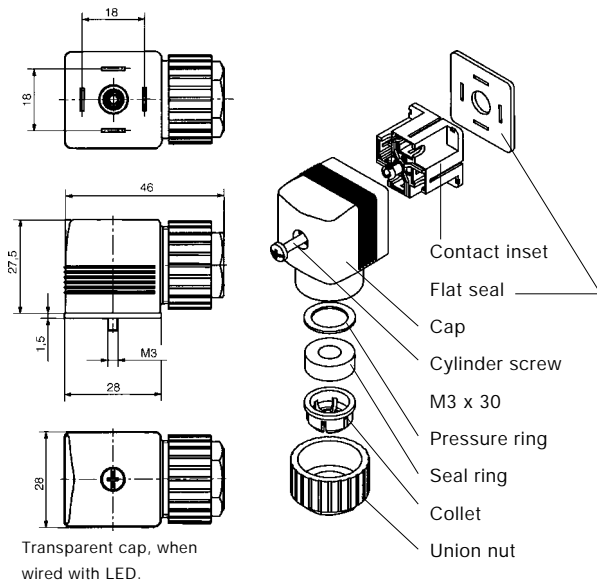

Ordering Chart for Accessories

Device/Accessory	Features	Order-No.
Cable-plugs¹⁾ Type 2508	Standard cable plug, 0-250 V AC/DC (standard-delivery) ¹⁾	008 376 N
	with LED, 12-24 V AC/DC	008 360 S
	with LED, 100-120 V AC/DC	008 361 P
	with LED + varistor, 12-24 V AC/DC	008 367 M
	with LED + varistor, 100-120 V AC/DC	008 368 W
	with LED + varistor, 200-240 V AC/DC	008 369 X
	(optional wirings and connection specifications see data sheet Type 2508)	

¹⁾ The standard cable plug (0-250 V AC/DC), Order-No. 008 376 N is part of the standard delivery. Ordering of optional cable plugs with separate ordering number.

A wide selection of further cable plugs is available (see special data sheet Type 2508)

DTS 1000011056 EN Version: C Status: RL (released | freigegeben | valide) printed: 09.05.2016