



INSERTION flowmeter with paddle wheel for continuous flow measurement

- Economic integration in pipe systems without any additional piping
- 3-wire frequency pulse version to directly interface with PLC's (both PNP and NPN)
- Connection to Bürkert devices in remote versions

Type 8020 can be combined with...



Type 8025

Flow transmitter



Type 8619

multiCELL
Transmitter/Controller



Type 8611

Universal Controller
eControl



Type 8802-GD

TopControl system

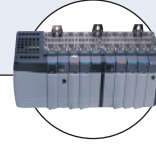

PLC

The paddle wheel flowmeter for continuous flow measurement is especially designed for use in neutral, slightly aggressive, solid free liquids.

The Bürkert designed fitting system ensures simple installation of the devices into all pipes from DN20 to DN400. The flowmeter produces a frequency pulse signal, proportional to the flow rate, which can easily be transmitted and processed by a Bürkert transmitter/controller.

General data	
Compatibility	With fittings S020 (see corresponding data sheet)
Materials	Housing / Union nut Cable plug Wetted parts materials Fitting Sensor armature, paddle wheel Axis, bearing / Seal
	PE / PC PA Brass, stainless steel 1.4404/316L, PVC, PP, PVDF PVDF Ceramics / FKM (EPDM option)
Electrical connection	Cable plug
Connection cable	1.5 mm ² cross section; max. 50 m length, shielded
Complete device data (fitting + electronic module)	
Pipe diameter	DN20...DN400
Measuring range	0.3...10 m/s
Medium temperature with fitting in PVC / PP Stainless steel, brass, PVDF	0...+50°C (32...122°F) / 0...+80°C (32...176°F) -15...+80°C (5...176°F)
Medium pressure max.	PN10 (145.1 PSI)
Viscosity / Pollution	300 cSt. max. / max. 1% (Size of particles 0.5 mm max.)
Measurement deviation	Teach-In Standard K-factor
	±1% of Reading ¹⁾ (at the teach flow rate value) ±2.5% of Reading ¹⁾
Linearity	±0.5% of FS.*
Repeatability	±0.4% of Reading ¹⁾
Environment	
Ambient temperature	-15...+60°C (5...+140°F) (operating and storage)
Relative humidity	≤ 80%, without condensation

* F.S. = Full scale (10 m/s)

¹⁾ Under reference conditions i.e. measuring fluid = water, ambient and water temperature = 20°C (68°F), applying the minimum inlet and outlet pipe straights, matched inside pipe dimensions.

Electrical data	
Operating voltage	12...36 V DC (via Bürkert transmitter for "Low Power" version)
Current consumption	with sensor
Pulse version	≤ 50 mA
Pulse "Low power" version	≤ 0.8 mA
Output: Frequency	
Pulse version	Transistor NPN/PNP, open collector, max. 100 mA, frequency: 0...300 Hz; duty cycle 1/2
Pulse "Low Power" version	Transistor NPN, open collector, max. 10 mA, frequency: 0...300 Hz; duty cycle 1/2
Reversed polarity of DC	Protected
Standards and approvals	
Protection class	IP65 with connector plugged-in and tightened
Standard and directives	
EMC	EN 61000-6-2, 61000-6-3
Pressure	Complying with article 3 of §3 from 97/23/CE directive.*
Vibration	EN 60068-2-6
Shock	EN 60068-2-27

* For the 97/23/CE pressure directive, the device can only be used under following conditions (depend on max. pressure, pipe diameter and fluid).

Type of fluid	Conditions
Fluid group 1, §1.3.a	DN 25 only
Fluid group 2, §1.3.a	DN ≤ 32 or DN > 32 and PN*DN ≤ 1000
Fluid group 1, §1.3.b	DN ≤ 25 or DN > 25 and PN*DN ≤ 2000
Fluid group 2, §1.3.b	DN ≤ 400

Pressure / temperature chart

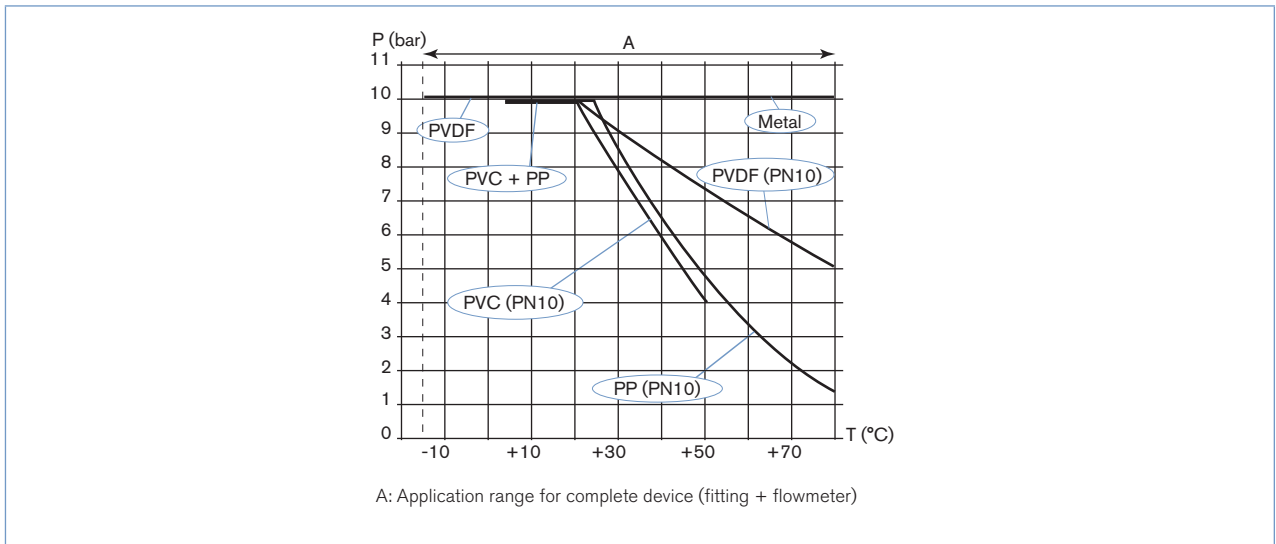

Design and principle of operation



The flowmeter 8020 consists of a transducer and a paddle-wheel with ceramic bearings. The ceramic rotating axis is set on the end of a PVDF INSERTION sensor armature. The transducer is mounted inside the armature. In a 3-wire system, the signal can be displayed or processed directly. The output signal is provided via cable plug.

When liquid flows through the pipe, the paddle-wheel is set in rotation. The non-wetted permanent magnets inserted in the paddle wheel generate a measuring signal which frequency is proportional to the flow velocity. A conversion coefficient (K-factor, available in the instruction manual of the fitting), specific to each pipe (size and material) enables the conversion of this frequency into flow rate.

Two electronic module versions with frequency output are available:

- with one pulse output (either NPN or PNP transistor output depending on wiring).
An external power supply of 12...36 V DC is required. It is designed for connection to any system with open collector NPN or PNP frequency input.

- with one pulse "Low Power" output (NPN transistor output).
An external power supply of 12...36 V DC is required. Can only be connected to separate versions of flow transmitters Type 8025/8032.

Installation

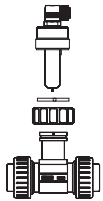

The 8020 flowmeter can easily be installed into any Bürkert INSERTION fitting system (S020) by just fixing the main nut.

Minimum straight upstream and downstream distances must be observed. According to the pipe's design, necessary distances can be bigger or use a flow conditioner to obtain the best result. The most important layouts that could lead to turbulence in the flow are shown below, together with the associated prescribed minimum inlet and outlet distances determined according to the standard EN ISO 5167-1.

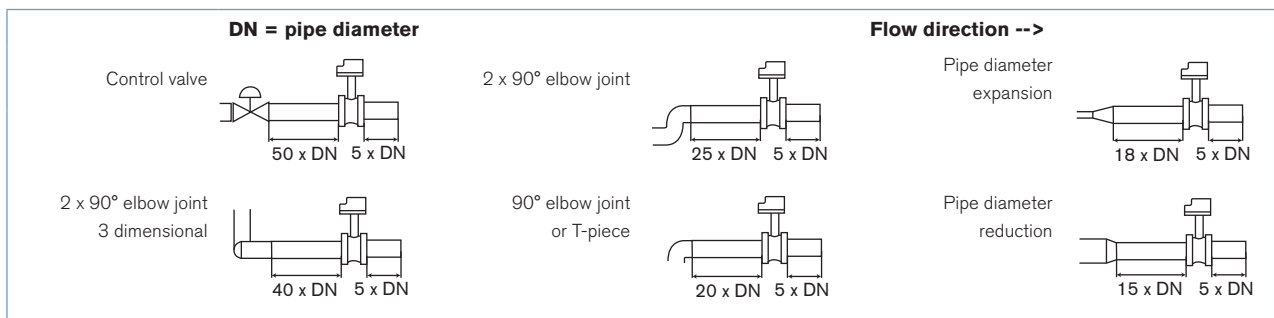

The device can be installed into either horizontal or vertical pipes. Mount the 8020 in these correct ways to obtain an accurate flow measurement.

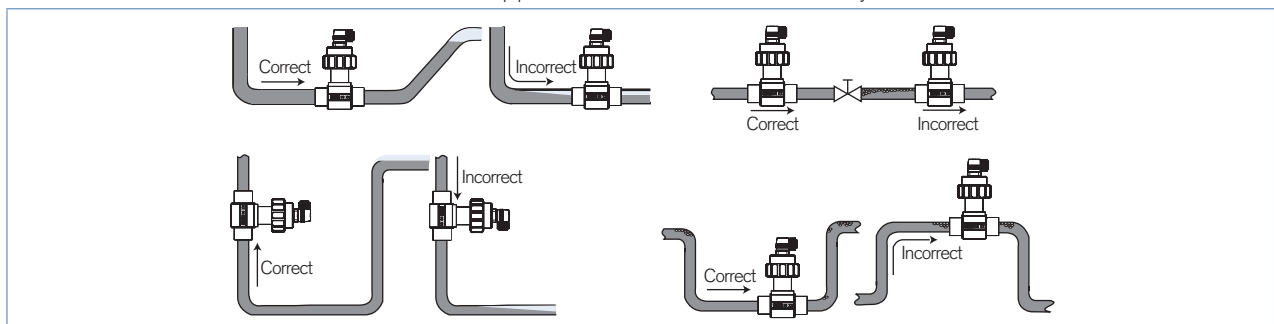

Pressure and temperature ratings must be respected according to the selected fitting material. The suitable pipe size is selected using the diagram Flow/Velocity/DN. The measuring device is not designed for gas flow measurement.

Diagram Flow/Velocity/DN

Example:

- Flow: 10 m³/h
- Ideal flow velocity: 2...3 m/s

For these specifications, the diagram indicates a pipe size of DN40 [or DN50 for (*) mentioned fittings]

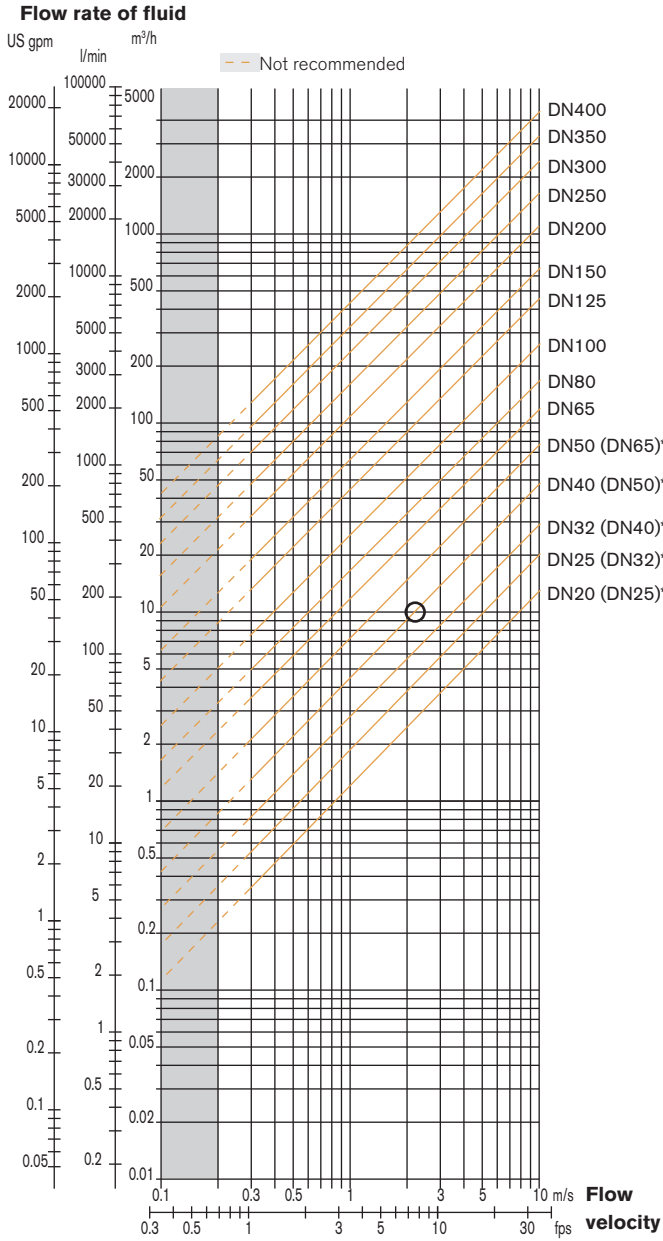

- * for following fittings with:
- external thread acc. to SMS 1145
 - weld end acc. to SMS 3008, BS 4825-1/ASME BPE/DIN 11866 series C or DIN 11850 series 2/ DIN 11866 series A/DIN EN 10357 series A
 - Clamp acc. to SMS 3017, BS 4825-3/ASME BPE or DIN 32676 series A

Dimensions

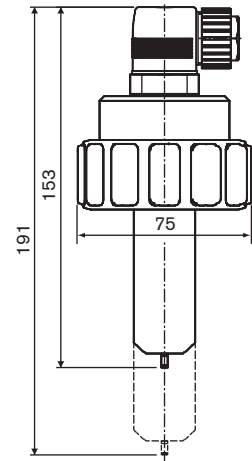

Note:

The length of the sensor armature depends on the fitting used. See data sheet Type S020.

More info.

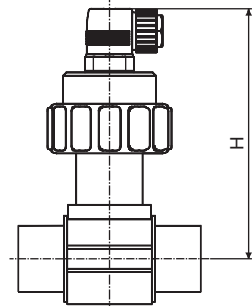

DN [mm]	H [mm]			
	T-Fitting	Saddle	Plastic spigot	St. St. spigot
20	153.5			
25	153.5			
32	157.0			
40	161.0			
50	167.0	191.5		162.5
65	167.0	190.5	172.5	167.0
80		194.5	177.5	173.0
100		199.5	184.0	183.5
110		195.5		
125		202.5		194.5
150		212.5	230.0	205.5
180		236.5		
200		248.5	251.0	226.0
250			269.0	286.0
300			280.5	305.5
350			294.0	317.5
400			308.5	

Ordering chart for flowmeter Type 8020

A flowmeter Type 8020 consists of: - a flowmeter Type 8020
 - an INSERTION fitting Type S020 (DN20...DN400 - Refer to corresponding data sheet - has to be ordered separately)

Description	Operating voltage	Output	Sensor version	Electrical connection	Item no.
Pulse version flowmeter (pluggable to Types 8025 Universal transmitter, batch controller or konti-Dos; 8032; PLC)	12...36 V DC	Frequency with pulse, PNP or NPN	short	Cable plug	419 587
			long	Cable plug	419 589
Pulse "Low Power" version flowmeter (pluggable to Types 8025, 8032 transmitter)	from associated transmitter	Frequency with pulse, NPN	short	Cable plug	419 591
			long	Cable plug	419 593

Ordering chart for accessories (has to be ordered separately)

Specifications	Item no.
Set with 1 green FKM and 1 black EPDM gasket	552 111
Ring	619 205
Union nut	619 204
Cable plug with cable gland (Type 2508)	438 811
Cable plug with NPT1/2" reduction without cable gland (Type 2509)	162 673

Interconnection possibilities with other Bürkert products

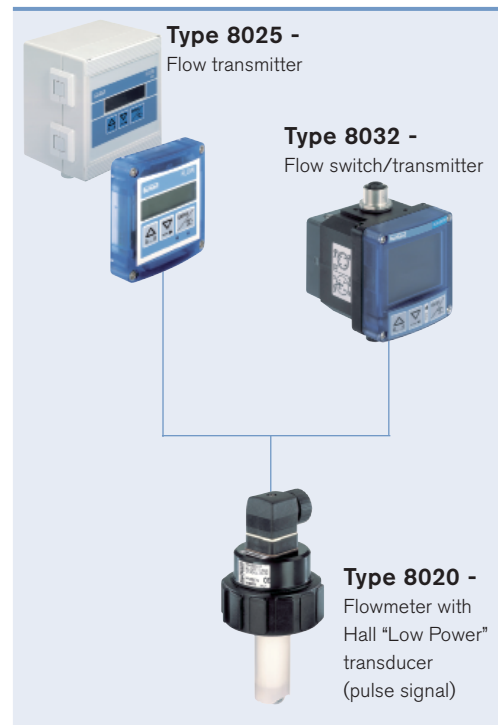
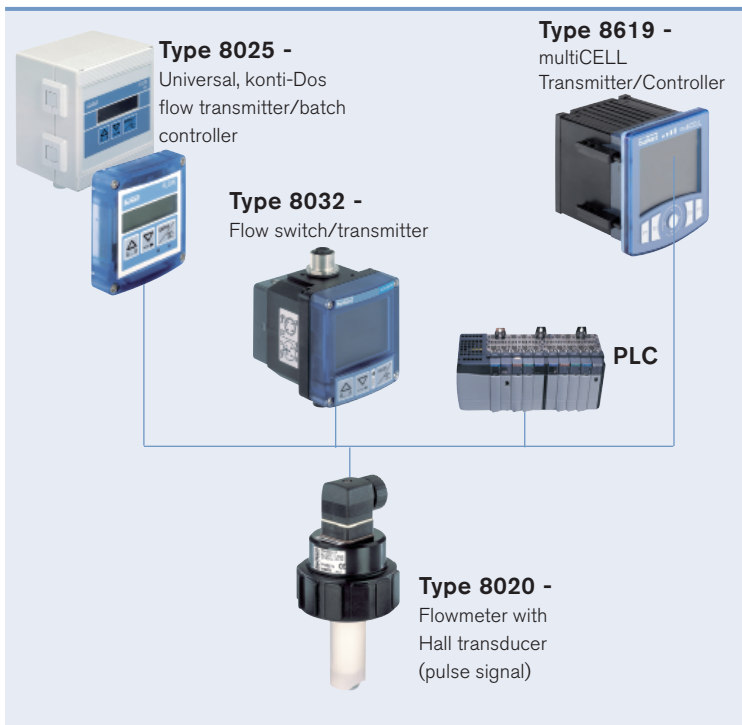

To find your nearest Bürkert office, click on the orange box →

www.burkert.com

In case of special application conditions, please consult for advice.

Subject to alteration.
 © Christian Bürkert GmbH & Co. KG

1511/12_EU-en_00891773

DTS 1000011076 EN Version: S Status: RL (released | freigegeben | valide) printed: 09.05.2016