

INLINE flowmeter for continuous flow measurement



- Economic integration in pipe systems without any additional piping
- 3-wire frequency pulse version to directly interface with PLC's (both PNP and NPN)
- Connection to Bürkert devices in remote versions

Type 8030 can be combined with...



Type 8025

Flow transmitter



Type 8611

Universal Controller
eControl



Type 8802-GD

Continuous
TopControl system



Type 8619

multiCELL
Transmitter/Controller

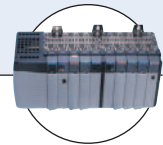

PLC

The paddle wheel flowmeter for continuous flow measurement is especially designed for use in neutral, slightly aggressive, solid free liquids.

The flowmeter is made up of a compact fitting (S030) and an electronic module (SE30) quickly and easily connected together by a Quarter-Turn. The Bürkert designed fitting system ensures simple installation of the devices into all pipes from DN06 to DN65. The flowmeter produces a frequency signal, proportional to the flow rate, which can easily be transmitted and processed by a Bürkert transmitter/controller.

General data	
Compatibility	With fittings S030 (see corresponding data sheet)
Materials	Housing, cover, male fixed connector: PC Cable plug / seal / screws: PA / NBR / Stainless steel Wetted parts materials: Brass, stainless steel 1.4404/316L, PVC, PP, PVDF Fitting, sensor armature: PVDF Paddle wheel: Ceramics / FKM or EPDM (depending on Sensor-Fitting version) Axis, bearing / Seal:
Electrical connection	Cable plug EN 175301-803 (Type 2508)
Connection cable	max. 1.5 mm ² cross section; max. 50 m length, shielded
Complete device data (fitting + electronic module)	
Pipe diameter	DN06 to DN65
Measuring range	0.3 to 10 m/s
Medium temperature with fitting in PVC / PP Stainless steel, brass, PVDF	0 to 50°C (32 to 122°F) / 0 to 80°C (32 to 176°F) -15 to 100°C (5 to 212°F)
Medium pressure max.	PN10 (with plastic fitting) PN16 (with metal fitting) (PN40 on request, see S030 data sheet)
Viscosity / Pollution	300 cSt. max. / max. 1% (Size of particles 0.5 mm max.)
Measurement error	Teach-In: ±1% of Reading ¹⁾ (at the teach flow rate value) Standard K-factor: ±2.5% of Reading ¹⁾
Linearity	±0.5% of F.S.* ¹⁾
Repeatability	±0.4% of Reading ¹⁾
Environment	
Ambient temperature	-15 to + 60°C (5 to 140°F) (operating and storage)
Relative humidity	≤ 80%, without condensation

* F.S. = Full scale (10 m/s)

¹⁾ Under reference conditions i.e. measuring fluid = water, ambient and water temperature = 20°C (68°F), applying the minimum inlet and outlet pipe straights, matched inside pipe dimensions.

Electrical data	
Operating voltage	12 - 36 V DC filtered and regulated (via Bürkert transmitter the device is connected for "Low Power" version)
Current consumption	with sensor
Hall version	≤ 30 mA
Hall "Low power" version	≤ 0.8 mA
Output: Frequency	
Hall version	2 transistors NPN and PNP, open collector, max. 100 mA, frequency: 0... 300 Hz; duty cycle 1/2 ±10% NPN output: 0,2-36 VDC PNP output: supply voltage
Hall "Low Power" version	1 transistor NPN, open collector, max. 10 mA, frequency: 0... 300 Hz; duty cycle 1/2 ±10%
Dielectric strength	2300 V AC
Reversed polarity of DC	Protected
Standards and approvals	
Protection class	IP65 with connector plugged-in and tightened
Standard and directives	
EMC	EN 61000-6-2, 61000-6-3
Pressure	Complying with article 3 of §3 from 97/23/CE directive.*
Vibration	EN 60068-2-6
Shock	EN 60068-2-27

* For the 97/23/CE pressure directive, the device can only be used under following conditions (dependent on max. pressure, pipe diameter and fluid).

Type of fluid	Conditions
Fluid group 1, §1.3.a	DN ≤ 25 only
Fluid group 2, §1.3.a	DN ≤ 32 or DN > 32 and PN*DN ≤ 1000
Fluid group 1, §1.3.b	PN*DN ≤ 2000
Fluid group 2, §1.3.b	DN ≤ 200

Pressure/temperature chart

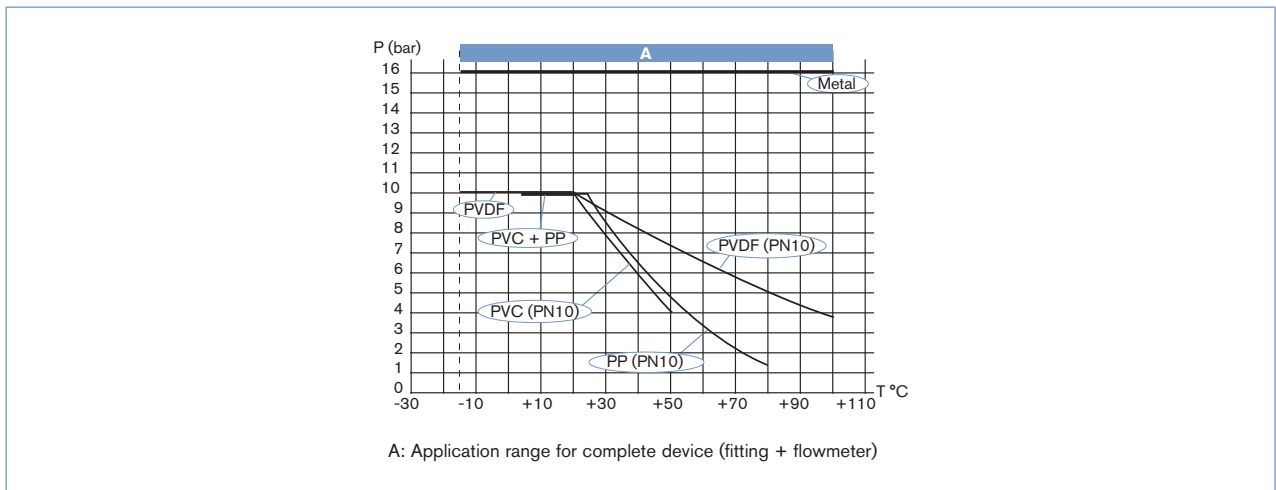

Design and principle of operation

The flowmeter 8030 is built up with an electronic module SE30 associated to a fitting S030 with integrated measurement paddle wheel. This connection is made by means of a Quarter-Turn.

In a 3-wire system, the signal can be displayed or processed directly. The output signal is provided via cable plug according to EN 175301-803.

When liquid flows through the pipe, the paddle-wheel is set in rotation. The non-wetted permanent magnets inserted in the paddle wheel generate a measuring signal which frequency is proportional to the flow velocity. A conversion coefficient (K-factor, available in the instruction manual of the fitting), specific to each pipe (size and material) enables the conversion of this frequency into flow rate.

Two electronic module versions with frequency output are available:

- with two transistor outputs NPN and PNP.

An external power supply of 12 - 36 V DC is required. It is designed for connection to any system with open collector NPN or PNP frequency input.

- with one NPN transistor "Low Power" output.

An external power supply of 12 - 36 V DC is required. Can only be connected to remote versions of flow transmitters Type 8025/8032.

Installation



The 8030 flowmeter can easily be installed into any Bürkert INLINE fitting system Type S030, by means of a Quarter-Turn. Minimum straight upstream and downstream distances must be observed. According to the pipe's design, necessary distances can be bigger or use a flow conditioner to obtain the best accuracy. For more information, please refer to EN ISO 5167-1.

EN ISO 5167-1 prescribes the straight inlet and outlet distances that must be complied with when installing fittings in pipe lines in order to achieve calm flow conditions. The most important layouts that could lead to turbulence in the flow are shown below, together with the associated prescribed minimum inlet and outlet distances. These ensure calm, problem-free measurement conditions at the measurement point.

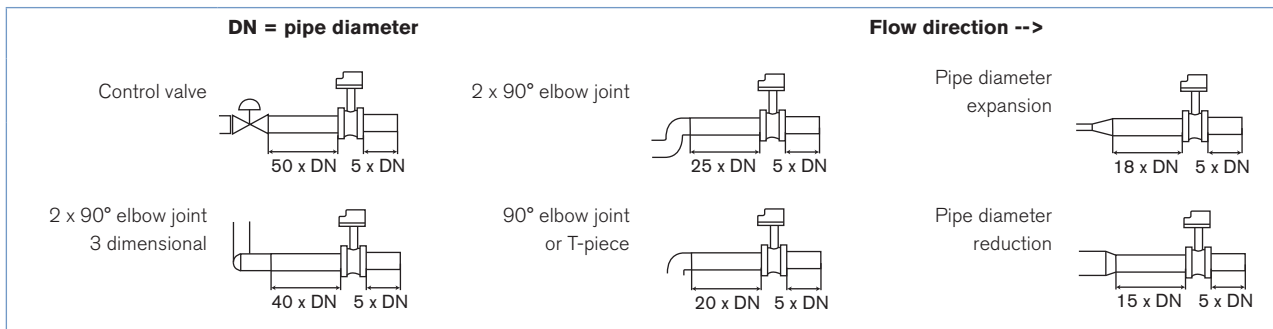

The device can be installed into either horizontal or vertical pipes.

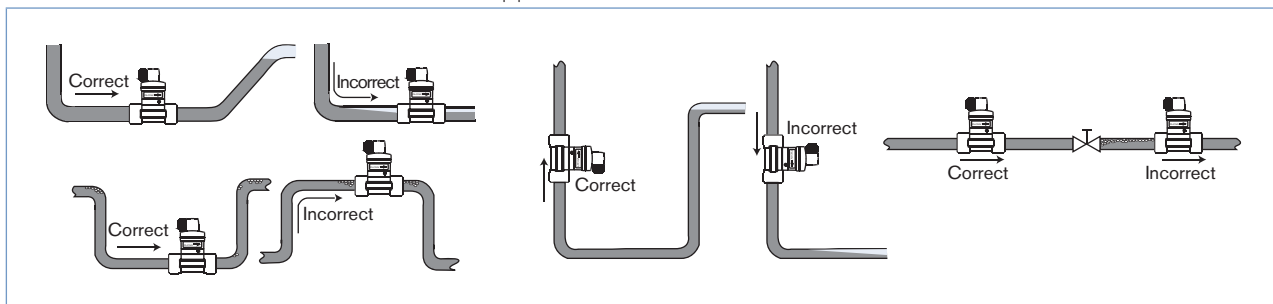

Pressure and temperature ratings must be respected according to the selected fitting material. The suitable pipe size is selected using the diagram Flow/Velocity/DN. The measuring device is not designed for gas flow measurement.

Diagram Flow/Velocity/DN

Example:

- Flow: 10 m³/h
- Ideal flow velocity: 2...3 m/s

For these specifications, the diagram indicates a pipe size of DN40 [or DN50 for (*) mentioned fittings]

Flow rate of fluid

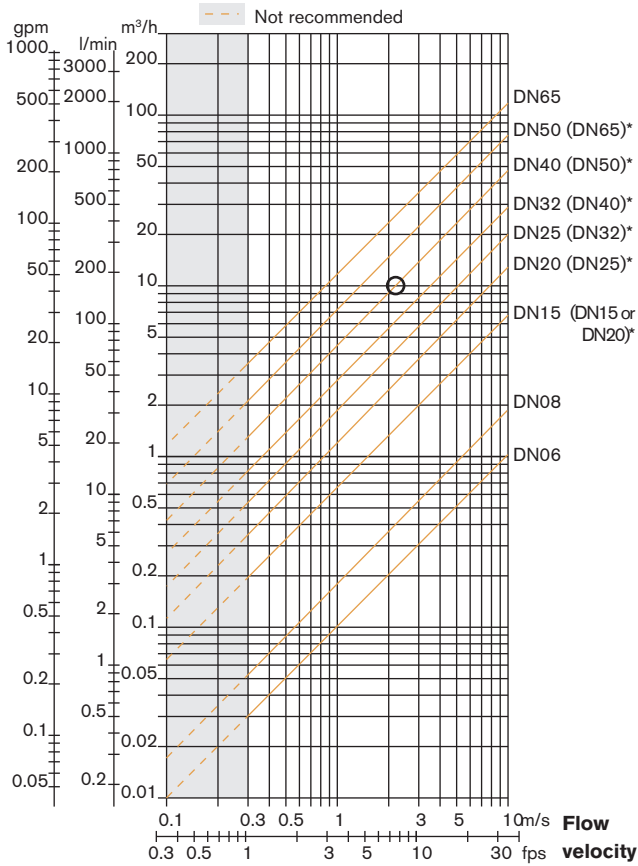

* for following fittings with:

- external threads acc. to SMS 1145
- weld ends acc. to SMS 3008, BS 4825/ASME BPE or DIN 11850 Series 2
- Clamp acc. to SMS 3017/ISO 2852, BS 4825/ASME BPE or DIN 32676

Dimensions

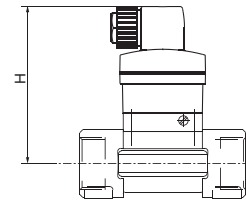
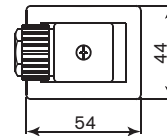
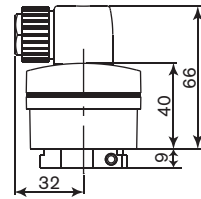

DN [mm]	H [mm]
06	95.5
08	95.5
15	100.5
20	98.0
25	98.0
32	102.0
40	105.5
50	112.0
65	112.0

Ordering chart for flowmeter Type 8030

A flowmeter Type 8030 consists of: - an electronic module Type SE30
 - an INLINE fitting Type S030 (DN06 to DN65 - Refer to corresponding data sheet)

Description	Voltage supply	Output	Electrical connection	Item no.
Hall version flowmeter (pluggable to Types 8025 Universal transmitter, batch controller or konti-Dos; 8032; 8619; PLC)	12 - 36 V DC	Frequency, 2 transistors NPN and PNP	Cable plug EN 175301-803	423 913
Hall "Low Power" version flowmeter (pluggable to Types 8025, 8032 transmitter)	from associated transmitter	Frequency, 1 transistor NPN	Cable plug EN 175301-803	423 914

Ordering chart for accessories (has to be ordered separately)

Specifications	Item no.
Cable plug EN 175301-803 with cable gland (Type 2508)	438 811
Cable plug EN 175301-803 with NPT1/2 " reduction without cable gland (Type 2509)	162 673

Interconnection possibilities with other Bürkert products

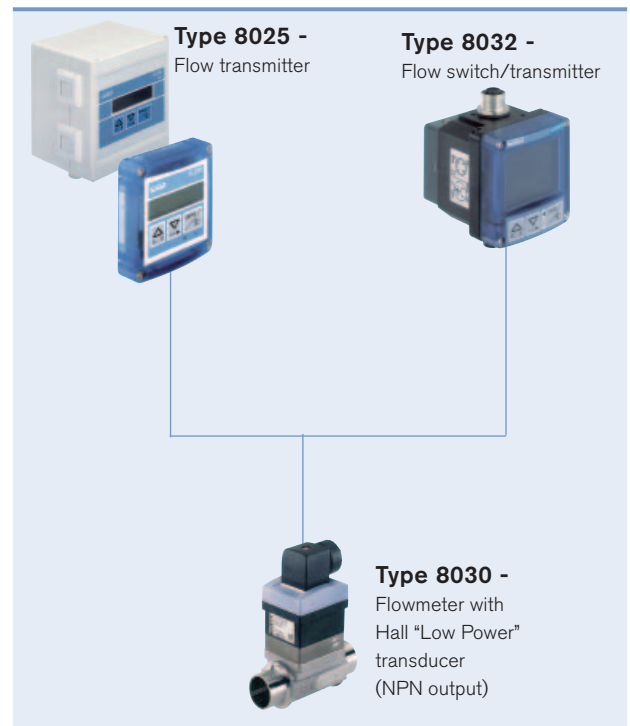
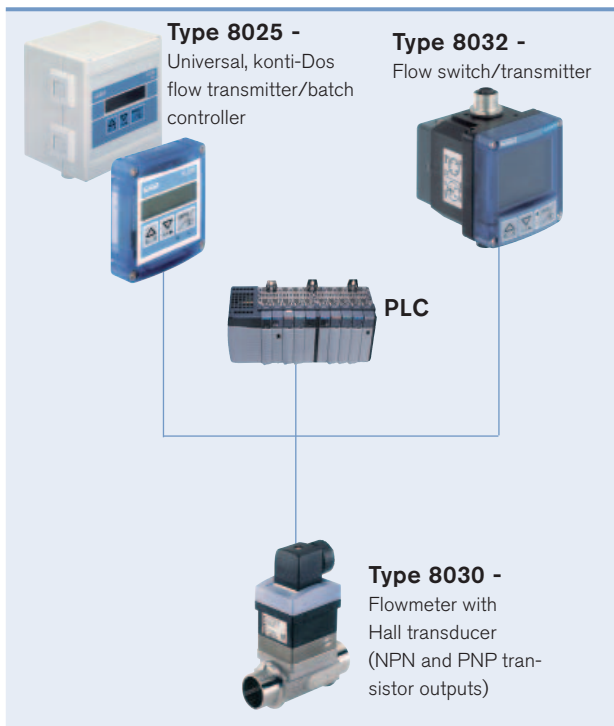

To find your nearest Bürkert office, click on the orange box →

www.burkert.com

In case of special application conditions, please consult for advice.

Subject to alteration.
 © Christian Bürkert GmbH & Co. KG

1401/14_EU-en_00891778